



USER MANUAL FOR AIB-2000 IO (INPUT-OUTPUT) BOX

April 01st, 2021



TABLE OF CONTENTS

1	DIMENSIONS.....	3
2	SPECIFICATIONS	4
3	FRONT AND REAR PANELS.....	5
4	ROUTING DIAGRAM.....	6
5	ETHERNET/ AES/EBU/ ANALOG OUT CONNECTION	7
6	SAFETY INSTRUCTIONS	8
7	REGULATORY INFORMATION	10
8	INTRODUCTION TO AIB-2000.....	11
8.1	About the AIB-2000.....	11
8.2	Unpacking and Checking for Shipping Damage	11
8.3	Packing Material	11
9	AIB-2000 CONNECTIONS.....	12
9.1	Installation	12
9.2	AC Mains Supply	12
9.3	Routing Diagram.....	12
9.4	Front Panel	13
9.4.1	Front NON-SYNC IN.....	13
9.4.2	MIC INPUT	13
9.4.3	SELECTOR	13
9.5	Rear Panel	14
9.5.1	7.1 Output.....	14
9.5.2	AES/EBU in.....	14
9.5.3	Ethernet in.....	14
9.5.4	LCR mon.....	14
9.5.5	H/I and V/I	14
9.5.6	7.1 Input.....	15

9.5.7 Rear NON-SYNC IN15

10 AIB-2000 REMOTE CONTROLS..... 16

11 AIB-2000 WEB INTERFACE 17

11.1 Default Access Credentials 17

11.2 Resetting AIB-2000 to Default Factory Settings..... 17

11.3 Accessing the Web Interface..... 18

11.4 About the AIB-2000 Web Interface..... 18

11.4.1 Control18

11.4.2 Config → IP config.....19

11.4.3 Config → Misc config20

11.4.4 Config → Reboot21

1 DIMENSIONS

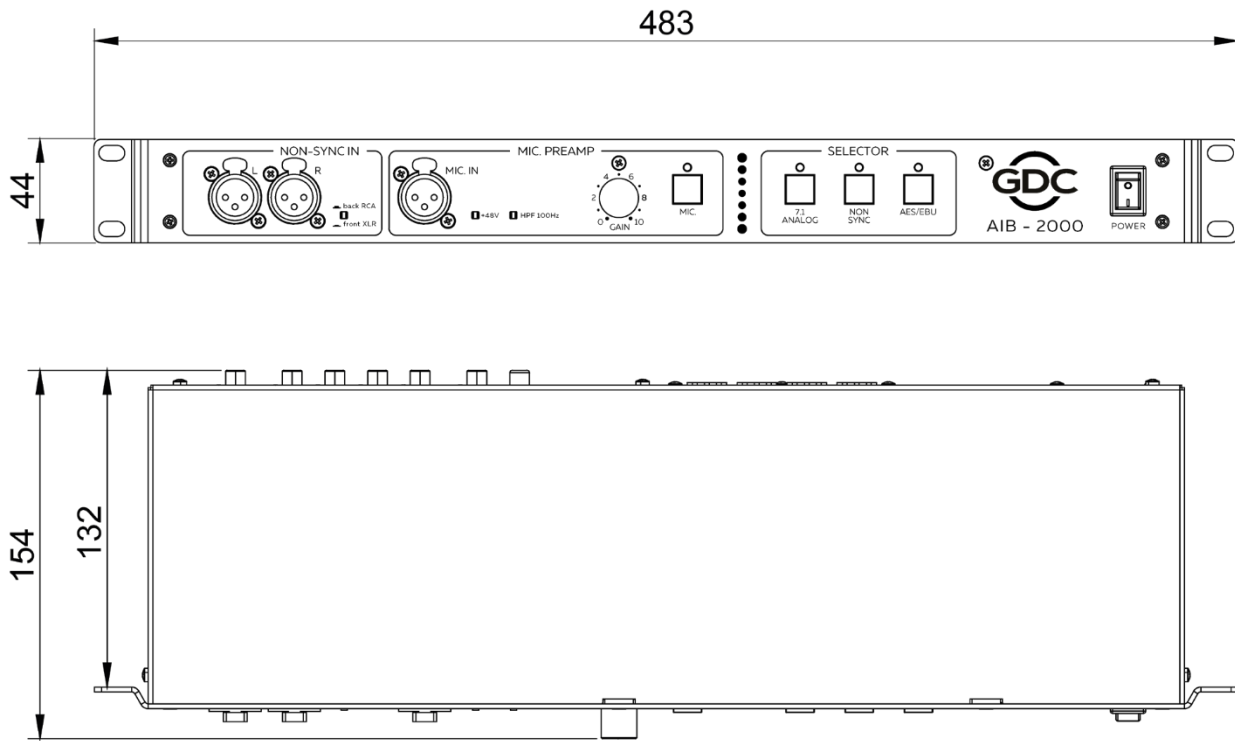

Figure 1: Dimensions of AIB-2000 Unit

2 SPECIFICATIONS

Frequency range	20 Hz - 20,000 Hz
Microphone input	XLR female
Microphone switch	Microphone in on/off
Microphone input HPF	100 Hz 12 dB/oct switchable
Microphone input phantom supply	+48 V switchable
Microphone input maximum gain	+60 dB
Non-Sync input	2 x XLR female (front) 2 x RCA (rear) switchable
Analog unbalanced 7.1 input	8 x RCA
Analog H/I output	1 x RCA
Analog V/I output	1 x RCA
Monitoring output L+C+R summed	1 x RCA
Analog balanced output	8 x 3-pin Phoenix
AES/EBU input	1 x RJ-45
Ethernet input	1 x RJ-45
Input selector	Non-sync / 7.1 Analog / AES/EBU
Mains plug	C14
Mains nominal voltage	90 V - 265 V / 50 - 60 Hz
Maximum power consumption	10 W
Rack height	1U
Dimensions (WxHxD)	483 x 44 x 158 mm
Shipping Dimensions (WxHxD)	550 x 70 x 255 mm
Net weight	2.1 kg
Shipping weight	3.2 kg

Table 1

3 FRONT AND REAR PANELS

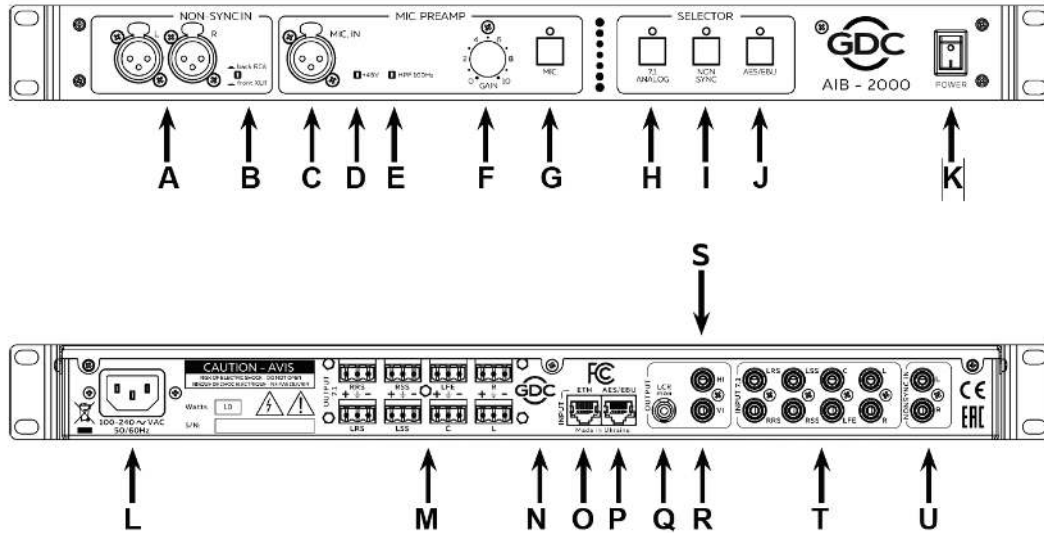

Figure 2: Front and Rear Panels of AIB-2000

A	ON-SYNC IN Left+Right XLR.
B	Front XLR - Back RCA NON-SYNC IN switch.
C	MIC IN XLR.
D	Phantom +48V switch.
E	HPF 100 Hz switch.
F	MIC IN gain knob.
G	MIC IN switch.
H	NON-SYNC selector.
I	7.1 Analog selector.
J	AES/EBU selector.
K	Mains switch.
L	C14 Mains socket.
M	7.1 Output phoenix sockets.
N	Serial number space – <i>DO NOT remove, scratch or modify serial number as this will immediately void the warranty.</i>
O	Ethernet input connector.
P	AES/EBU input connector.
Q	LCR monitor output.
R	V/I output.
S	H/I output.
T	7.1 Input.
U	NON-SYNC IN Left+Right RCA.

Table 2

4 ROUTING DIAGRAM

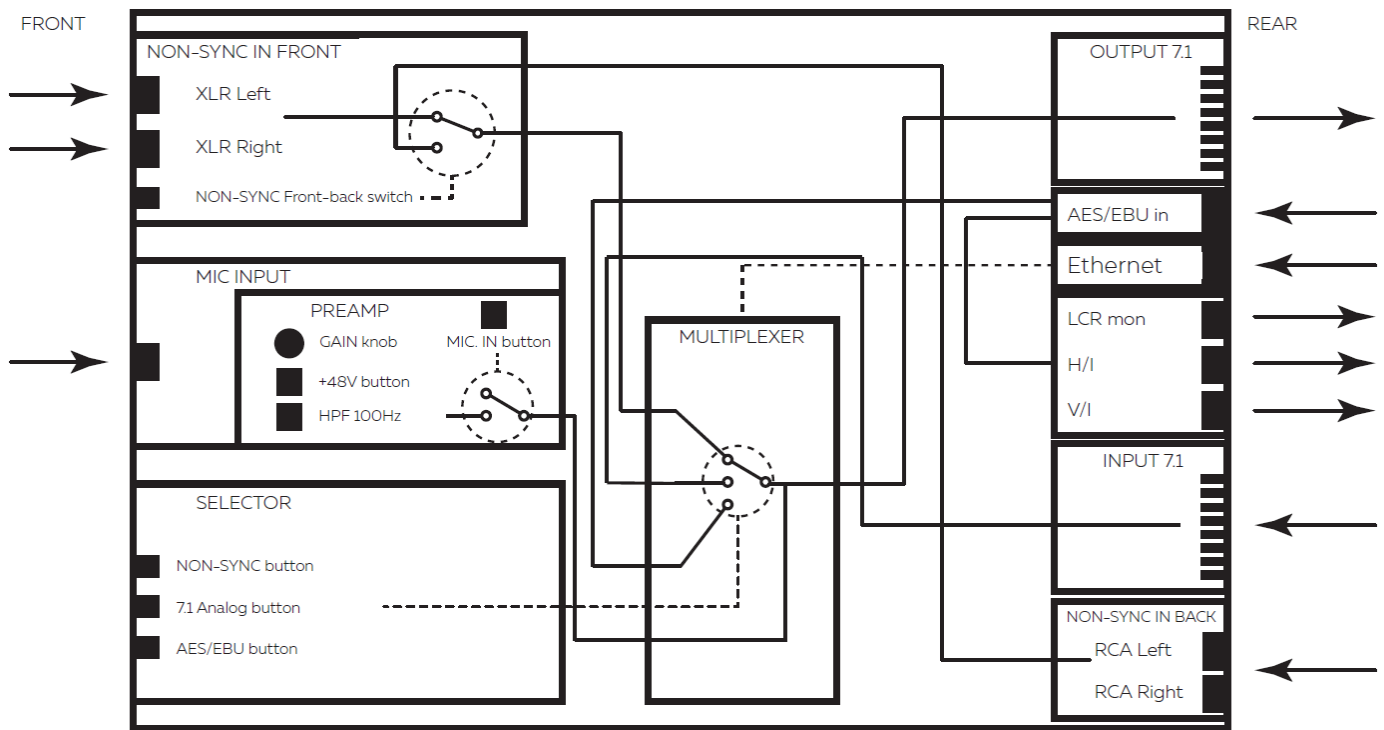
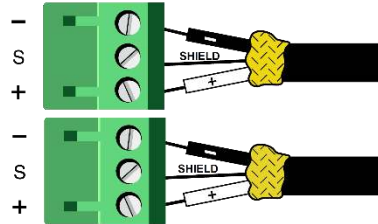

Figure 3: Routing Diagram for AIB-2000

5 ETHERNET/ AES/EBU/ ANALOG OUT CONNECTION

Analog outputs

BALANCED LINES



UNBALANCED LINES

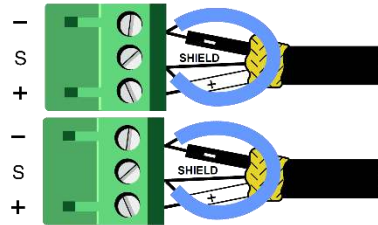

ETH In

1	ETH TX+	GREEN/WHITE	
2	ETH TX-	GREEN	
3	ETH RX+	ORANGE/WHITE	
4		BLUE	
5		BLUE/WHITE	
6	ETH RX-	ORANGE	
7		BROWN/WHITE	
8		BROWN	

AES/EBU In

1	AES/EBU 1+	GREEN/WHITE	
2	AES/EBU 1-	GREEN	
3	AES/EBU 2+	ORANGE/WHITE	
4	AES/EBU 3+	BLUE	
5	AES/EBU 3-	BLUE/WHITE	
6	AES/EBU 2-	ORANGE	
7	AES/EBU 4+	BROWN/WHITE	
8	AES/EBU 4-	BROWN	

6 SAFETY INSTRUCTIONS

EXPLANATIONS OF GRAPHICAL SYMBOLS



The triangle with the lightning bolt is used to alert the user to the risk of electric shock.



The triangle with the exclamation point is used to alert the user to important operating or maintenance instructions.



The CE-mark indicates compliance with low voltage and electromagnetic compatibility.



Symbol for earth/ground connection.



Symbol indicating that the equipment is for indoor use only.



Symbol for conformity with Directive 2002/96/EC and Directive 2003/108/EC of the European Parliament on waste electrical and electronic equipment (WEEE).



WARNING: TO REDUCE THE RISK OF ELECTRIC SHOCK, DO NOT ATTEMPT TO OPEN ANY PART OF THE UNIT. NO USER-SERVICEABLE PARTS INSIDE. REFER SERVICING TO QUALIFIED SERVICE PERSONNEL.



TO COMPLETELY DISCONNECT THIS APPARATUS FROM THE AC MAINS, DISCONNECT THE POWER SUPPLY CORD PLUG FROM THE AC RECEPTACLE.



THE MAINS PLUG OF THE POWER SUPPLY CORD MUST REMAIN READILY ACCESSIBLE.



DO NOT EXPOSE THIS EQUIPMENT TO RAIN OR MOISTURE, DRIPPING OR SPLASHING LIQUIDS. OBJECTS FILLED WITH LIQUIDS, SUCH AS VASES, SHOULD NOT BE PLACED ON THIS APPARATUS.



WHEN THE UNIT IS INSTALLED IN RACK CABINET OR A SHELF, MAKE SURE THAT IT HAS SUFFICIENT SPACE ON ALL SIDES TO ALLOW FOR PROPER VENTILATION (50 CM FROM THE FRONT AND REAR VENTILATION OPENINGS).



CONNECTIONS TO THE MAINS SHALL BE DONE ONLY BY AN ELECTROTECHNICALLY SKILLED PERSON ACCORDING TO THE NATIONAL REQUIREMENTS OF THE COUNTRIES WHERE THE UNIT IS SOLD.



IMPORTANT SAFETY INSTRUCTIONS

1. Read these instructions carefully.
2. Keep these instructions.
3. Heed all warnings.
4. Follow all instructions.
5. Do not use this equipment near water.
6. Clean only with a dry cloth.
7. Do not block any ventilation openings. Install in accordance with the manufacturer's instructions.
8. Do not use near heat sources such as stoves, heat registers, radiators or other equipment (including amplifiers) that produces heat.
9. Do not use the unit near open fire sources.
10. Connect the unit only to the electric network with grounding. Use only electric plugs that provide grounding.
11. Protect the power cord from being walked on, pinched or otherwise damaged.
12. Use only accessories specified by the manufacturer.
13. Unplug this unit during lightning storms or when unused for long periods.
14. Refer all servicing to qualified service personnel. Servicing is required when the system has been damaged in any way, such as power supply cord or plug is damaged, liquid has been spilled or objects have fallen into the unit, the unit has been exposed to rain or moisture, does not operate normally or has been dropped.
15. **WARNING** - TO REDUCE THE RISK OF FIRE OR ELECTRIC SHOCK, DO NOT EXPOSE THIS SYSTEM UNIT TO RAIN OR MOISTURE.

THIS UNIT CONTAINS POTENTIALLY LETHAL VOLTAGES. TO PREVENT ELECTRIC SHOCK OR HAZARD, DO NOT REMOVE THE COVER. NO USER-SERVICEABLE PARTS INSIDE. REFER SERVICING TO QUALIFIED SERVICE PERSONNEL.

INSTALLING OF THIS UNIT MUST BE PERFORMED ONLY BY QUALIFIED TRAINED PERSONNEL FOLLOWING APPLICABLE SAFETY RULES. DO NOT ALLOW INSTALLING OF THIS UNIT IF INSTALLATION HARDWARE IS BROKEN, BENT, PARTS ARE MISSING OR IS OTHERWISE DAMAGED.

7 REGULATORY INFORMATION

FCC COMPLIANCE STATEMENT

This device complies with Part 15 of the FCC rules. Operation is subject to the following two conditions:

(1) This device may not cause harmful interference and (2) this device must accept any interference received, including interference that may cause undesired operation.

CAUTION: Changes or modifications not expressly approved by the party responsible for compliance could void the user's authority to operate the equipment.

NOTE: This equipment has been tested and found to comply with the limits for a Class B digital device, pursuant to Part 15 of the FCC Rules. These limits are designed to provide reasonable protection against harmful interference in a residential installation. This equipment generates, uses and can radiate radio frequency energy and, if not installed and used in accordance with the instruction manual, may cause harmful interference to radio communications. However, there is no guarantee that interference will not occur in a particular installation. If this equipment does cause harmful interference to radio or television reception, which can be determined by turning the equipment off and on, the user is encouraged to try to correct the interference by one or more of the following measures:

- Reorient or relocate the receiving antenna.
- Increase the separation between the equipment and receiver.
- Connect the equipment into an outlet on a circuit different from that to which the receiver is connected.
- Consult the dealer or an experienced radio/TV technician for help.

8 INTRODUCTION TO AIB-2000

8.1 About the AIB-2000

The AIB-2000 is a complementary input/output device compatible with most cinema power amplifiers.

It provides functionality to connect additional signal sources, like satellite receivers, DVD-players and cable receivers and offers dedicated H/I, V/I and LCR outputs. AIB-2000 is compatible with AIB-2000 macroprotocol and is easily controlled with media server automation commands.

Please refer to the '[Audio Processing Settings for SR-1000](#)' document for additional information on how to interface the AIB-2000 with the GDC SR-1000 Media Server and Cinema Sound System.

8.2 Unpacking and Checking for Shipping Damage

Your AIB-2000 has been completely tested and inspected before leaving the factory. Carefully inspect the shipping package before opening it and then immediately inspect your new product. If you find any damage notify the shipping company immediately.

The packing box contains the following:

- One AIB-2000.
- One AC Mains Power Cord.
- This User Manual.

8.3 Packing Material

Please retain the original packaging of the AIB-2000 for RMA shipments.

NOTE: The transport and protective packing has been selected from materials that are environmentally friendly, which can normally be recycled.

9 AIB-2000 CONNECTIONS

9.1 Installation

The AIB-2000 is a 1U Rack device and most conveniently installed in the amplifier rack it connects to.

NOTE: Instead of connecting the AIB-2000 to the power grid directly, it is recommended to plug the device's mains connection to a UPS outlet.

9.2 AC Mains Supply

The AC Main connection is made via the **IEC C13** connector.



Make sure the AC mains voltage used is within the acceptable operating voltage range: 115V-230V \pm 10%.



It is important to connect the ground for safety, do not use adapter that disables the ground connection.



The DC series amplifiers have an automatic power factor correction system - PFC - for a perfect mains network interface. The PFC minimizes the reactive power reflected on the network and reduces the harmonic distortion on voltage/current waveform: in this way the amplifier is seen as a resistive load from the mains network. Furthermore, the system allows performance to be maintained even in case of varying mains voltage.



Connection to the main shall be done only by an electro technically skilled person according to the national requirements of the countries where the unit is sold.



9.3 Routing Diagram

Refer to **Section 4** for the signal routing diagram of your AIB-2000.

9.4 Front Panel

The front panel provides 2 x XLR NON-SYNC inputs, XLR MIC input with preamp and input-to-output routing selector, as shown in **Figure 4**.



Figure 4: AIB-2000 Front Panel

9.4.1 Front NON-SYNC IN

Frontal **left and right XLR NON-SYNC** inputs provide the user with the possibility of connecting an additional stereo device with line-level outputs.

NON-SYNC front/back button switches Non-Sync input between frontal XLR and rear RCA connectors. Non-Sync in can be routed to 7.1. Output by selecting the **NON-SYNC** button on the front.

9.4.2 MIC INPUT

Microphone input with preamplifier is provided for the convenience of making announcements, including emergency messages.

- **GAIN** knob controls the gain of the preamplifier.
- **+48V** button switches the +48 V phantom power supply ON and OFF.
- **HPF 100Hz** button switches the built-in microphone high-pass filter on and off.
- **MIC IN** button switches microphone input ON and OFF.

9.4.3 SELECTOR

The SELECTOR section controls the source for 7.1. OUTPUT connectors on the back.

- **NON-SYNC** button chooses the Non-Sync in.
- **7.1 ANALOG** button chooses the input from 7.1. INPUT connectors on the back.
- **AES/EBU** button chooses the signal from digital AES/EBU in on the back.

9.5 Rear Panel

The rear panel houses 7.1 Output Phoenix connections, AES/EBU RJ-45 connector, Ethernet RJ-45 connector, LCR mon, H/I, V/I outputs, 7.1. input RCA connectors and 2 x RCA NON-SYNC connectors, as shown in **Figure 5**.



Figure 5: Rear Panel of AIB-2000

9.5.1 7.1 Output

8 x 3-pin Phoenix connectors provide analog output for connection to Analog amplifiers. Source of the 7.1. output is selected by SELECTOR switches on the front.

9.5.2 AES/EBU in

AES/EBU RJ-45 connector receives the AES/EBU stream which can be routed to 7.1. output by selecting the **AES/EBU** button on the front. Refer to **Section 4** for the correct wiring of the AES/EBU RJ-45 socket.

9.5.3 Ethernet in

Ethernet RJ-45 connector receives the control automation signals from the media server. Refer to **Section 4** for the correct wiring of the Ethernet RJ-45 socket.

9.5.4 LCR mon

LCR mon provides monitoring output which is received from the AES/EBU stream. Please note that the LCR mon output provides a L+C+R summation of the AES inputs to the AIB-2000.

9.5.5 H/I and V/I

H/I and V/I outputs are extracted from AES/EBU stream and provides for cinema-goers with hearing and vision difficulties.

NOTE: The H/I and V/I outputs are derived from AES/EBU Channels 7 & 8. Please use the H/I and V/I AES outputs from the SR- 1000 when using the 'GDC Channel Assignment Preset Output Routing'. Please refer to the '[Audio Processing Settings for SR-1000](#)' document for more details.

9.5.6 7.1 Input

8 x RCA connectors are provided for analog input from 7.1. signal source. 7.1. Input can be routed to 7.1. output by selecting the **7.1. ANALOG** button on the front.

9.5.7 Rear NON-SYNC IN

Rear left and right RCA NON-SYNC inputs provide the user with the possibility of connecting an additional stereo device with line-level outputs.

NON-SYNC front/back button on the front switches Non-Sync input between frontal XLR and rear RCA connectors. Non-Sync in can be routed to 7.1. Output by selecting the **NON-SYNC** button on the front.

10 AIB-2000 REMOTE CONTROLS

AIB-2000 can be controlled remotely from a PC, Media Server or other devices. Communication is implemented through an Ethernet connection.

Control allows switching of the input source from AES, 7.1 ANALOG and NON-SYNC, turning ON/OFF MIC, setting MIC output to CENTER/SIDE SURROUND channels.

The AIB-2000 can be controlled from the SR-1000 (with audio processing enabled) by choosing the default AIB-2000 device in the SR-1000 Automation settings. For more details, please refer to the '[Audio Settings for SR-1000](#)' document.

11 AIB-2000 WEB INTERFACE

The AIB-2000 provides a user with a web interface to access its controls. AIB-2000 must be connected to a wired or a wireless network via the ETH port. The device used for accessing the web interface must be in the same network as the AIB-2000.

11.1 Default Access Credentials

Default factory network settings for AIB-2000 are as follows:

- IP Address: **192.168.0.8**
- Network mask: **255.255.255.0**
- Gateway: **192.168.0.1**
- Username: *Please contact GDC for the user name and password of the web interface*
- Password: *Please contact GDC for the user name and password of the web interface*

11.2 Resetting AIB-2000 to Default Factory Settings

To reset the IP address to default, turn off the AIB-2000, press and simultaneously hold **7.1 ANALOG** and **AES/EBU** buttons and turn on the device. Wait until all three Selector LEDs are lit and then release the buttons.

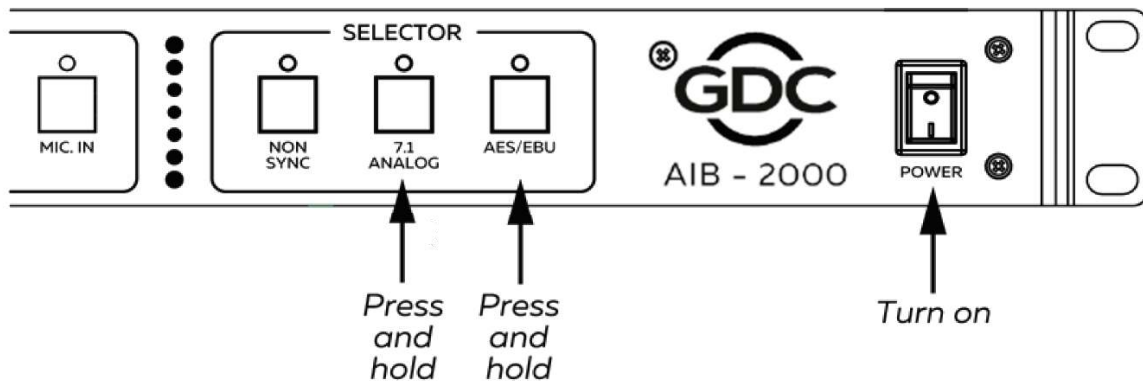

Figure 6: Reset to Default Factory Settings

11.3 Accessing the Web Interface

Make sure your computer is in the same network as the AIB-2000 and has the same network mask. Open a web browser and enter the IP of the AIB-2000 in the Address bar. Enter the login credentials and click on the **Sign In** button.

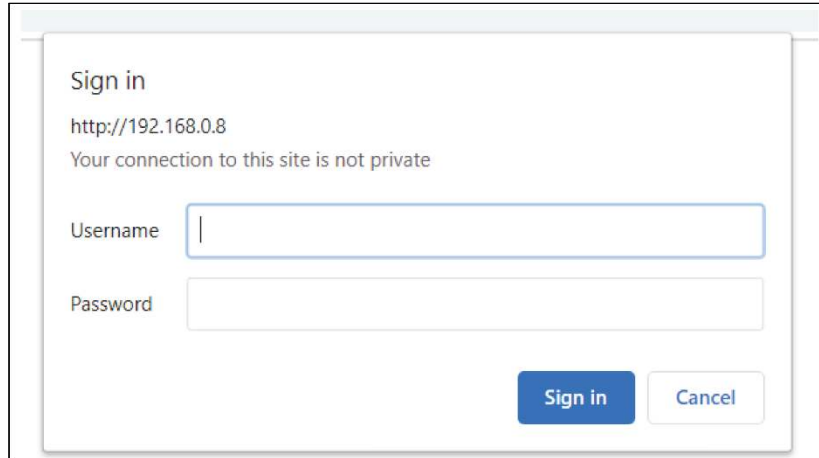

Figure 7: Accessing the Web Interface

11.4 About the AIB-2000 Web Interface

The AIB-2000 Web Interface contains two menus: **Control** and **Config**.

11.4.1 Control

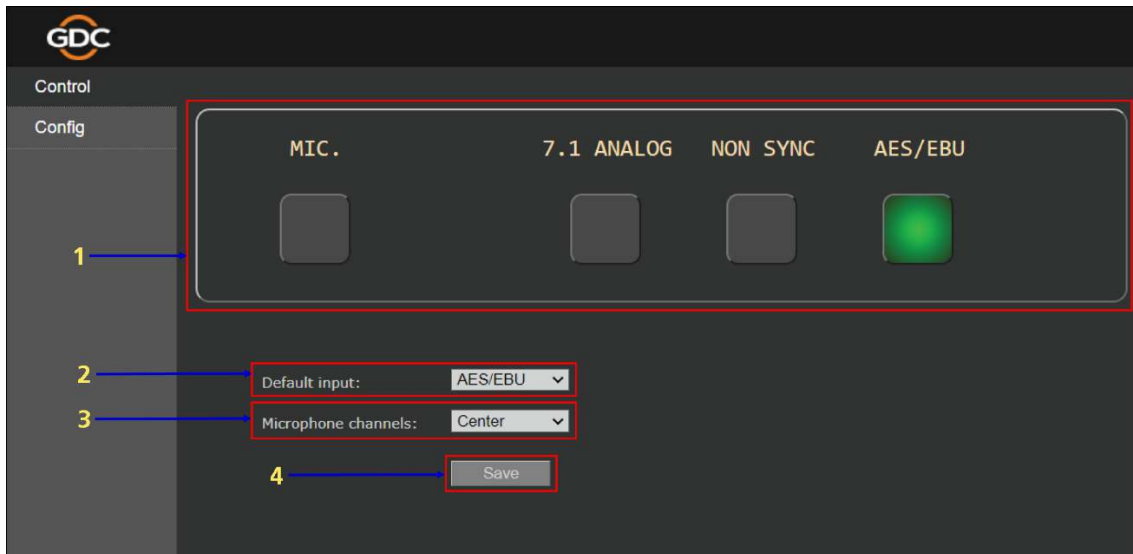

Figure 8: Control

Sr. No.	Name	Function Description
1	[MIC./ 7.1 ANALOG/ NON SYNC/ AES/EBU]	Allows the user to switch between 7.1 Analog, Non Sync, AES/EBU inputs and turn mic. on and off (duplicates controls on the front panel).
2	[Default input:]	Allows the user to select the input that should be chosen when the device boots up.
3	[Microphone channels:]	Allows the user to select the destination for the mic. between Center or Surround speakers
4	[Save]	Apply changes to the Default input and Microphone channels.

Table 3

11.4.2 Config → IP config

The IP config sub-menu allows the user to set network parameters for the AIB-2000.

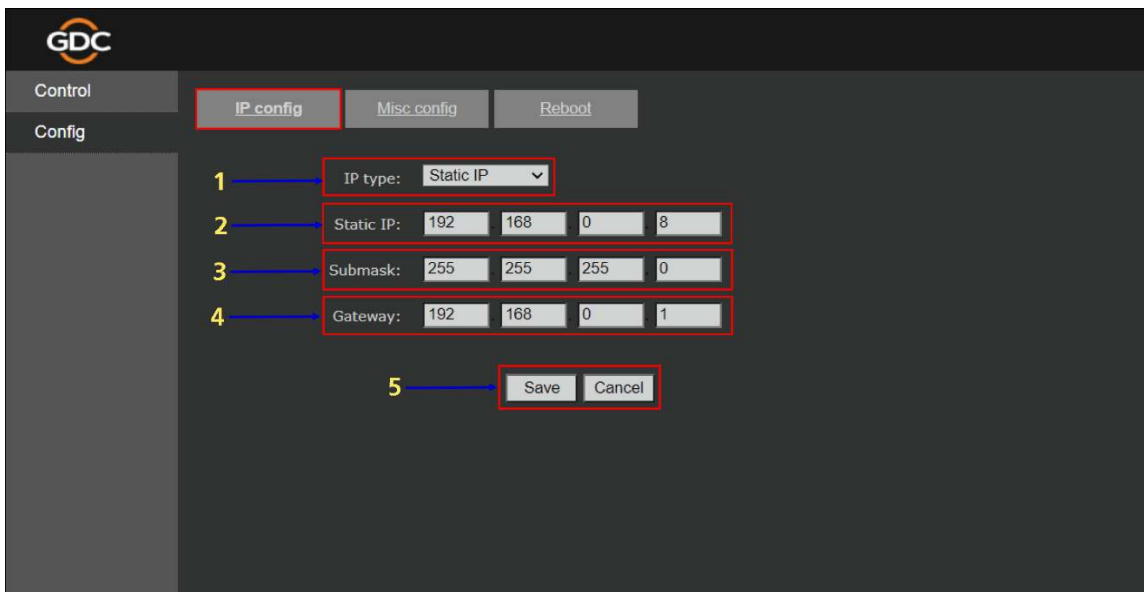

Figure 9: IP config

Sr. No.	Name	Function Description
1	[IP type:]	Allows the user to choose between 'Static IP' or 'Receive IP from DHCP server'.

2	[Static IP:]	Specify the IP address for the AIB-2000.
3	[Submask:]	Specify the subnet mask for the AIB-2000.
4	[Gateway:]	Specify the network gateway for the AIB-2000.
5	[Save / Cancel]	Click on Save to apply the changes. Click on Cancel to discard the changes.

Table 4

11.4.3 Config → Misc config

The **Misc config** sub-menu allows the user to set the Username and Password for the AIB-2000.

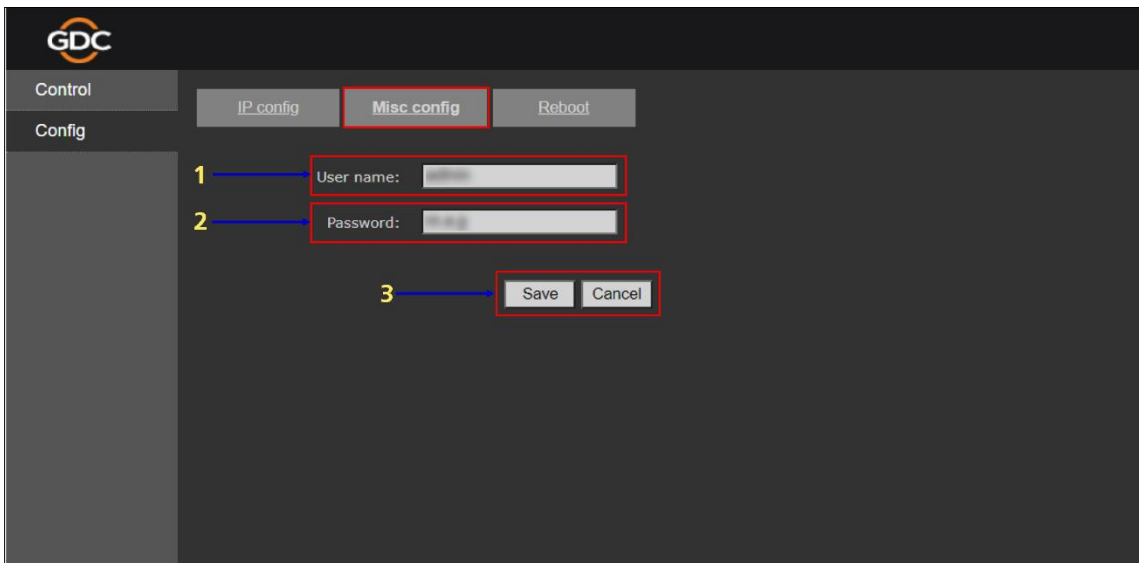

Figure 10: Misc config

Sr. No.	Name	Function Description
1	[User name:]	Allows the user to change the username.
2	[Password:]	Allows the user to change the password.
3	[Save / Cancel]	Click on Save to apply the changes. Click on Cancel to discard the changes.

Table 5

11.4.4 Config → Reboot

The **Reboot** sub-menu allows the user to reboot the AIB-2000 by clicking the **Reboot Device** button.

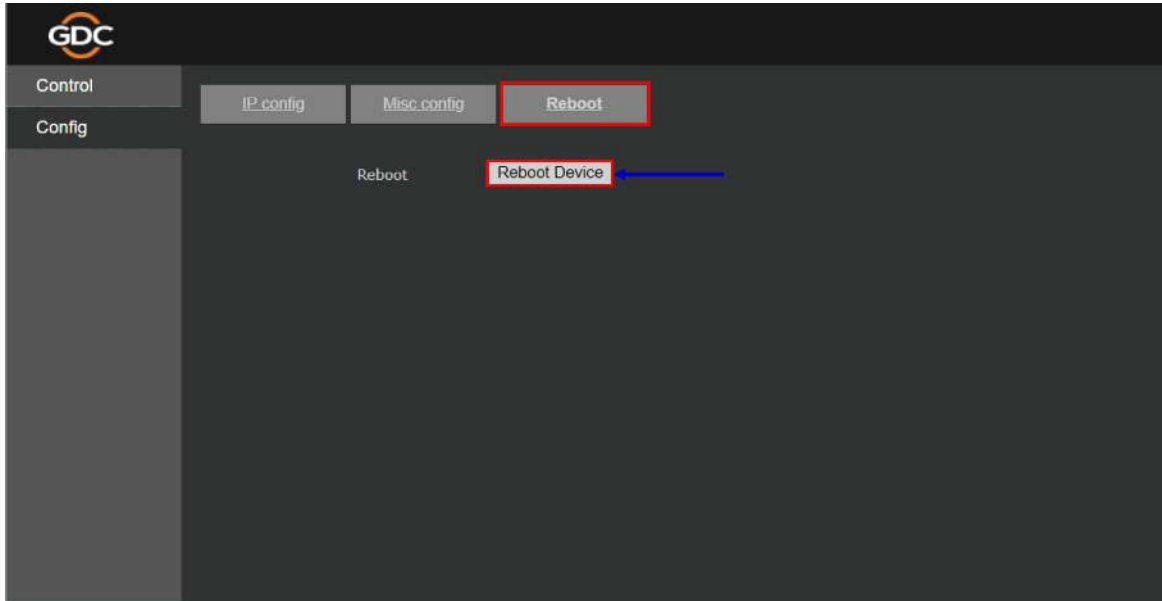

Figure 11: Reboot